

GREINATAFLA T1.5 Hesja staðsett við útidyr í kompu - bil 108

Kvísil frá T1.0 - 3X125A/400V
5 x 50q AI

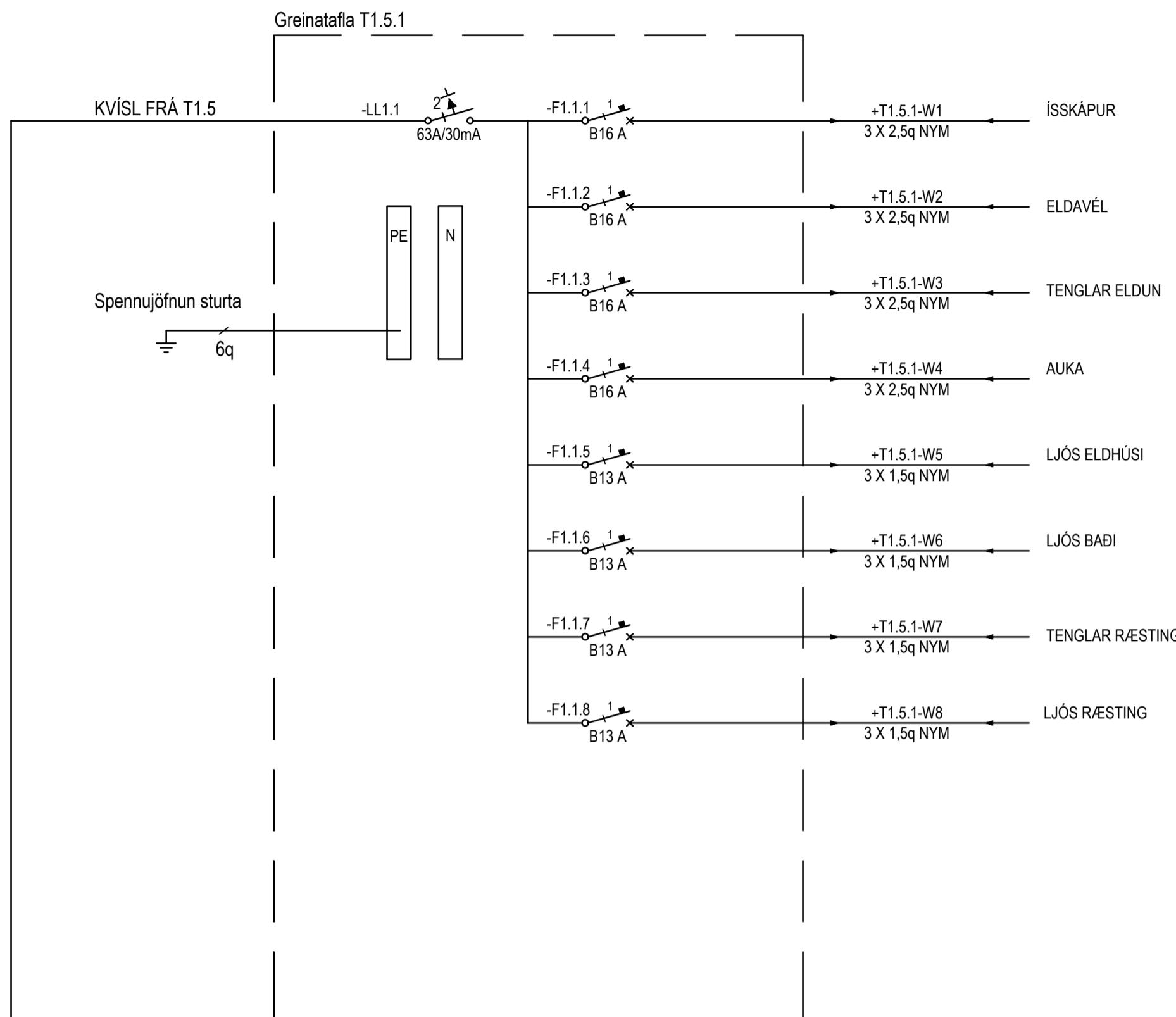
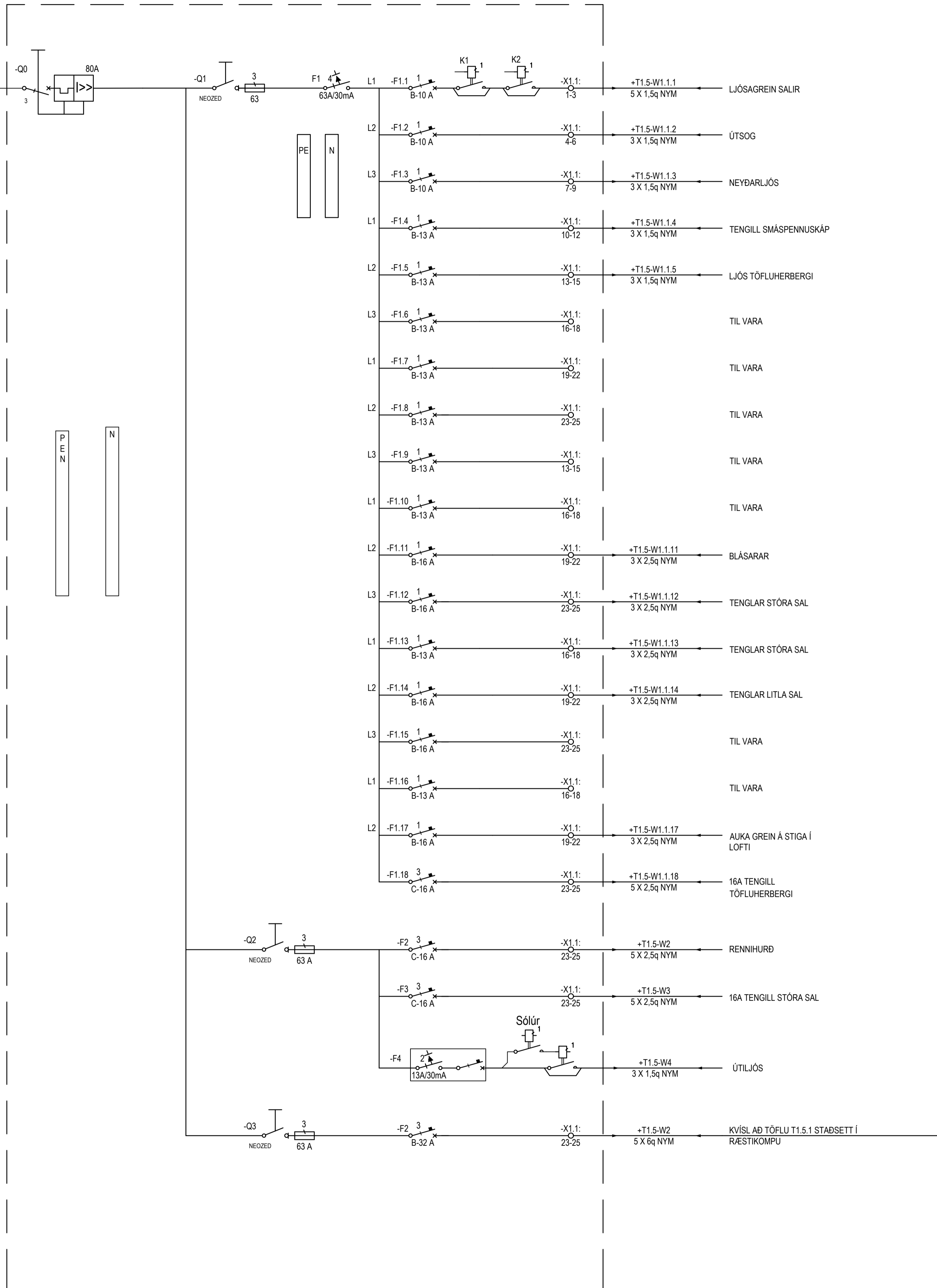

ÚTG.	DAGS.	ÚTGÁFUFRILL	HANNAÐ	TEKNI.	YFRIF.
-	-	-	-	-	-
-	-	-	-	-	-
-	-	-	-	-	-
-	-	-	-	-	-
-	-	-	-	-	-
-	-	-	-	-	-
-	-	-	-	-	-
-	-	-	-	-	-
-	-	-	-	-	-

TESLA ehf
Raflagna- og lýsingarhönnun
Svanbjörn Einarsson, kt.180265-3339
698-2624, svanbjorn@teslaehf.is

Iðnaðarhúsnæði
Selhella 1
221 Hafnarfjörður
Rafkerfi
Greinatafla T1.5 - Hesja bil 108

TEKNI. NÚMÉR	BLADSTÆRÐ	HANNAÐ	SVE
04032020.01	A1	TEKNI.	SVE
01_15_05		YFRIF.	SVE
DAGS.	MÆLIKVARDI	ÚTGÁFA	
2024.05.28	1:50	A	

Dagsetning áskilpóttar: n/1dags
Hönnuður: Svanbjörn Einarsson kt.180265-3339
Hönnunarsjón: Bjarni Þór Ólafsson kt.280769-3559

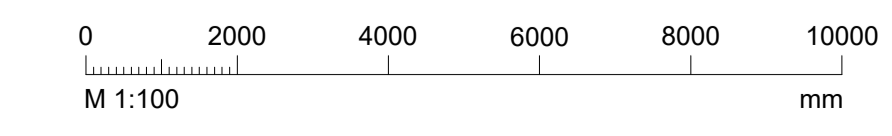

T:\Verkheimildir\2020.03.04 Selhella 1\4. Vinnugögn\Teikningar\01_40 Almennt raflagnr.dwg

ÚTG.	DAGS.	ÚTGAUFERILL	HANNAÐ	TEKNI.	YFIRF.
-	-	-	-	-	-
-	-	-	-	-	-
-	-	-	-	-	-
-	-	-	-	-	-
-	-	-	-	-	-
-	-	-	-	-	-
-	-	-	-	-	-
-	-	-	-	-	-
-	-	-	-	-	-
-	-	-	-	-	-

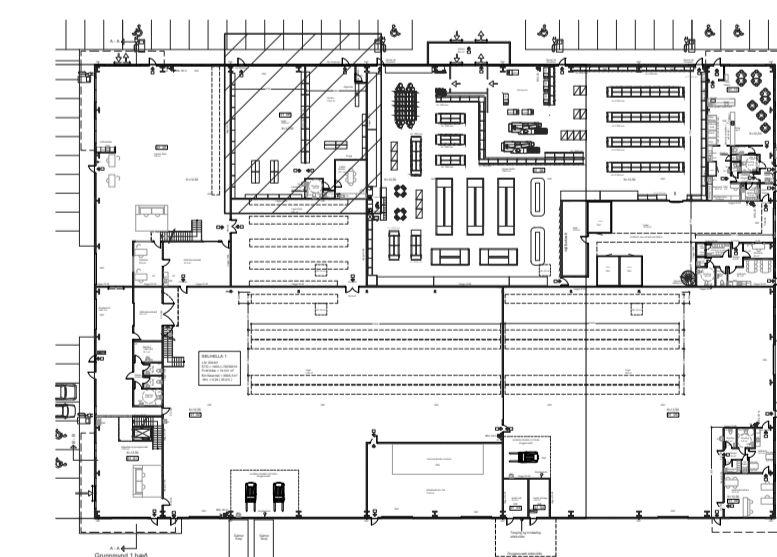
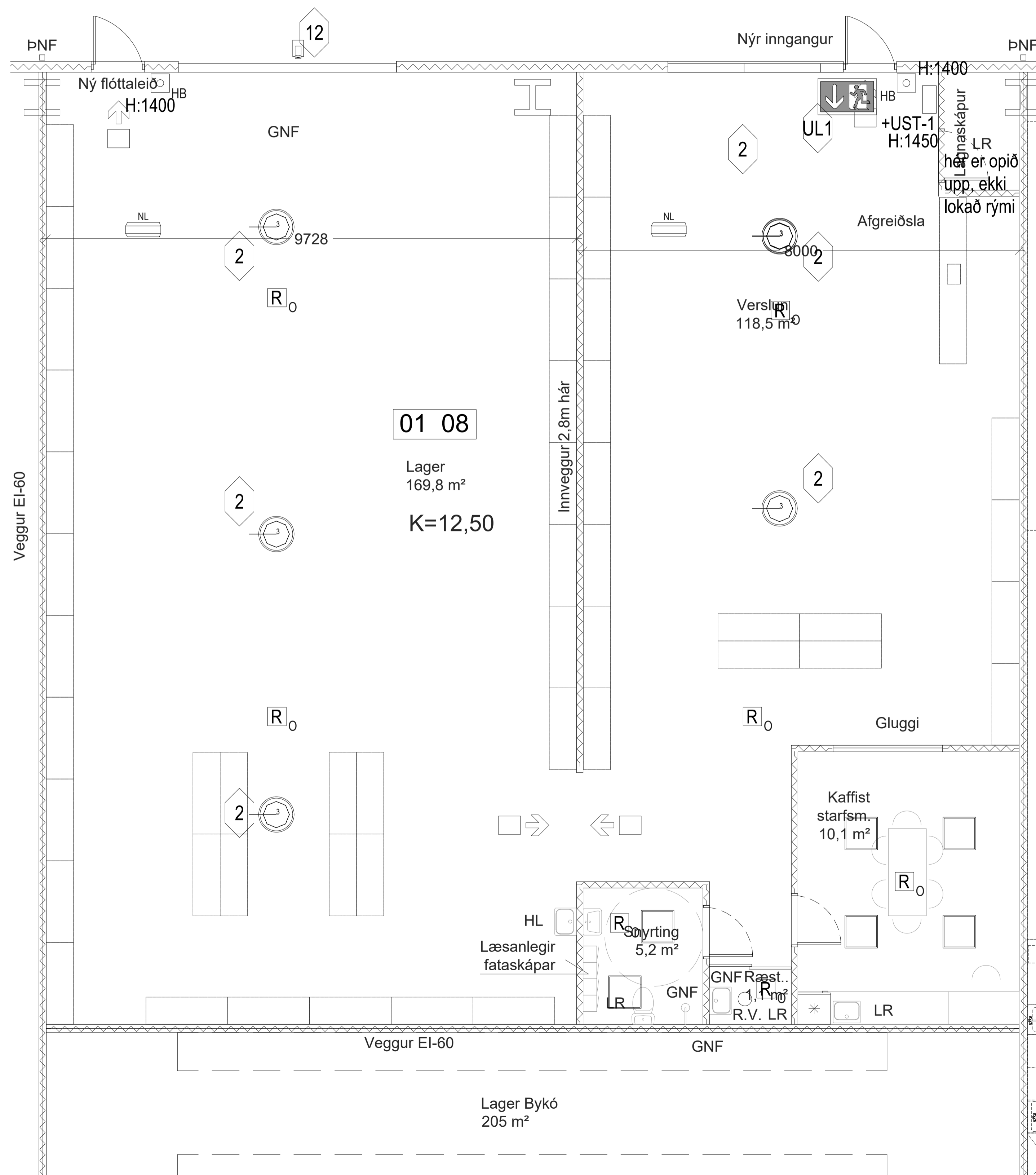

Íönaðarhúsnæði
 Selhella 1
 221 Hafnarfjörður
 Rafkerfi
 Ljós og brunaviðvörðunarkerfi bil 0108
 Hesja

TEKNIÐMÉR	BLAÐSTÆRD	HANNAÐ	SVE
04032020.01	A1	TEKNAÐ	SVE
01_30_03		YFIRFARID	SVE
DAGS.	MÆLIKVARDI	ÚTGAFA	
2024.05.28	1:50	A	

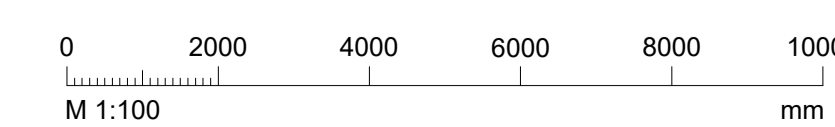

Dagsetning aðaluppdráttar: n/dags
 Hönnuður: Svanbjörn Einarsson kt.180265-3339
 Hönnunarsjón: Bjarni Þór Ólafsson kt.280769-3559

ÚTG.	DAGS.	ÚTGAUFERILL	HANNAÐ TEKN. YFIR.
---	---	---	---
---	---	---	---
---	---	---	---
---	---	---	---
---	---	---	---
---	---	---	---
---	---	---	---
---	---	---	---
---	---	---	---
---	---	---	---

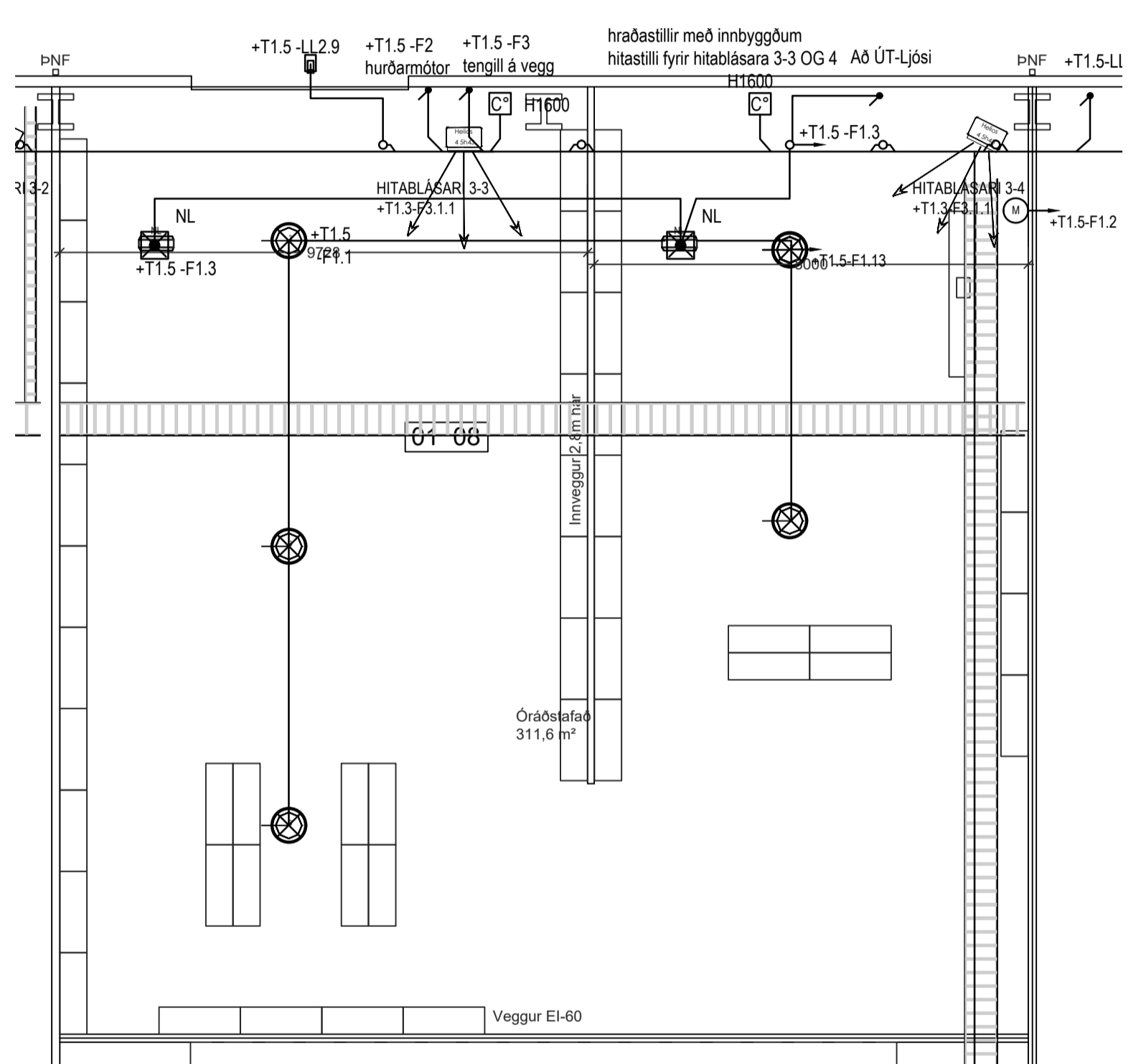
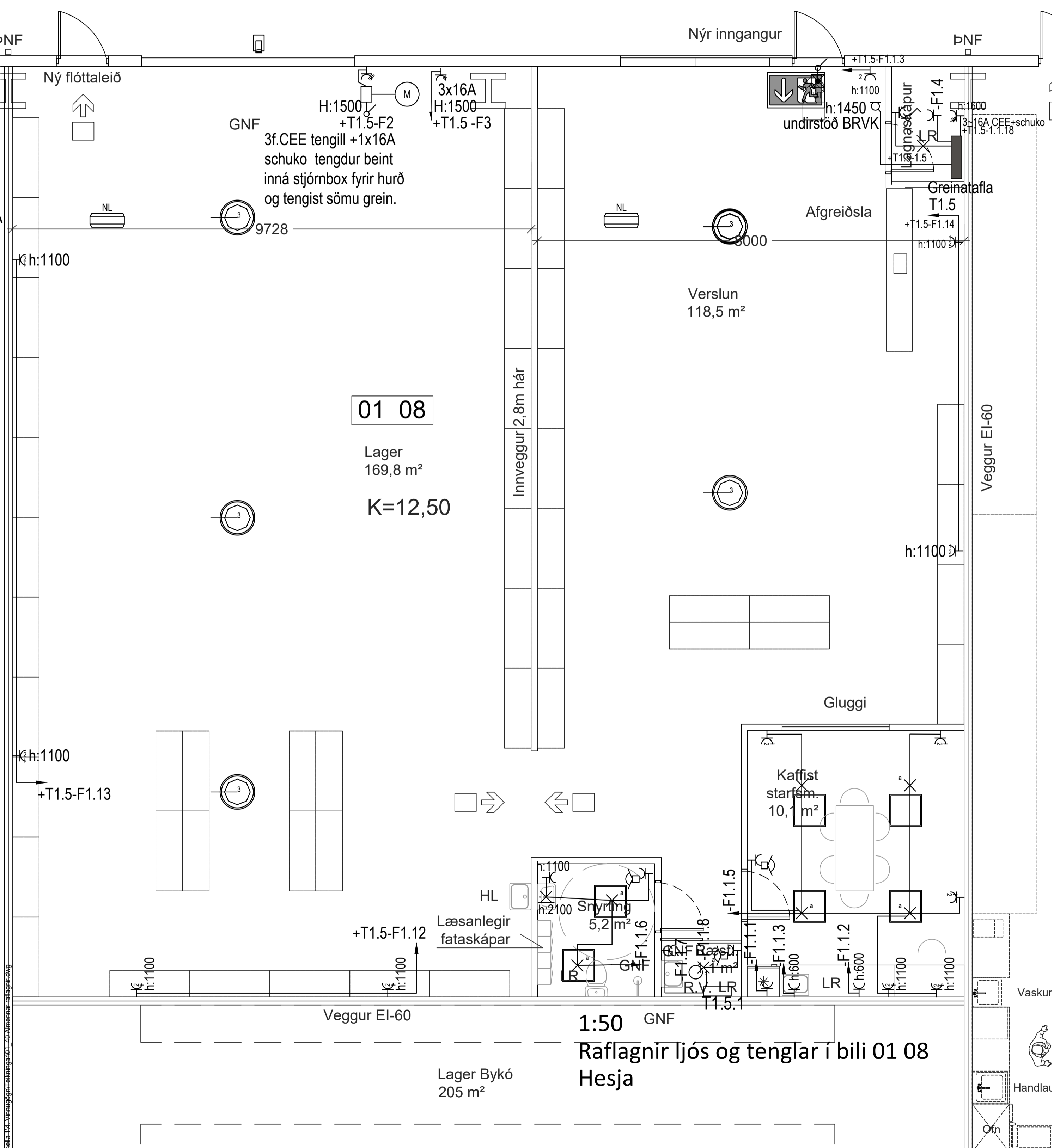

1:100
 Raflagnir í lofti í bili 01 08
 Hesja

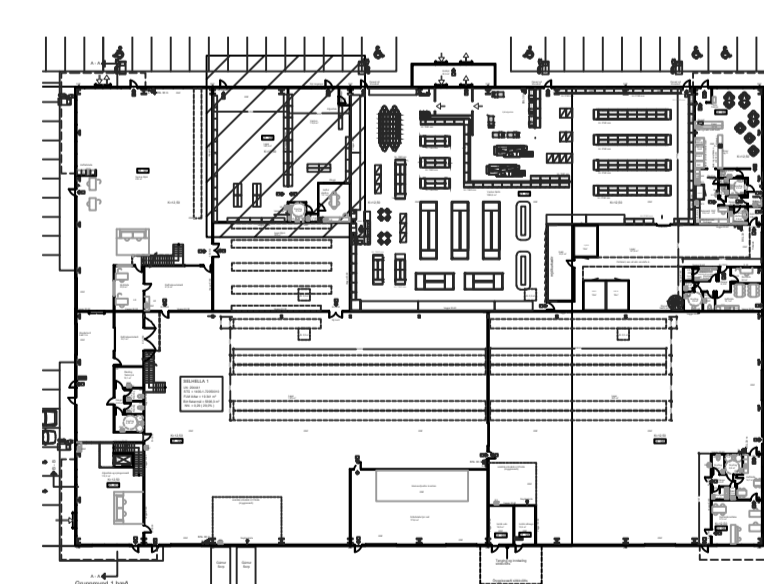

Íðnaðarhúsnæði
 Selhella 1
 221 Hafnarfjörður

Rafkerfi
 Almennar raflagnir
 1.hæð

TEKNIÐMÉR	BLAÐSTÆRD	HANNAÐ	SVE
04032020.01	A1	TEKNAÐ	SVE
01_40_03		YFIRFARID	SVE

DAGS.	MÆLIKVARÐI	ÚTGAFA
2021.01.11	1:100	A

